

Article number: 60415236018

Description: Timing Belt Pulley 36 AT5 18/2

Measures

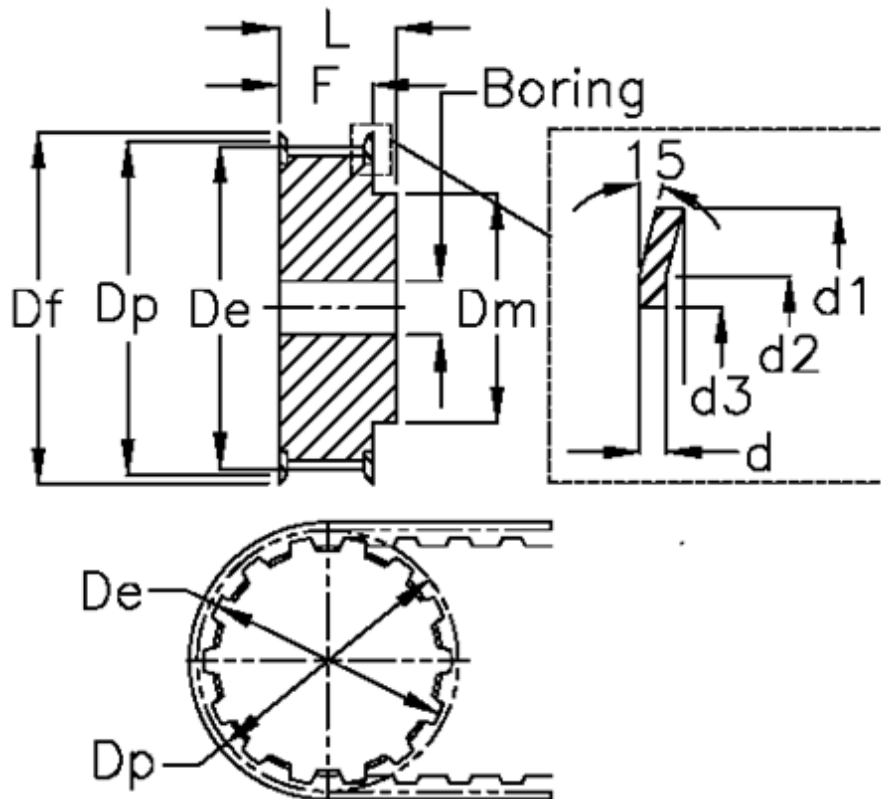

Belt width = - 25 mm	D_p	= 28.7
d = 1	F	= 30
d_1 = 32	Flange type	= F10
d_2 = 27.5	L	= 36
d_3 = 23	Pre-drilled	= 6
D_e = 27.4	Tooth number	= 18
D_f = 32	Type	= AT5
D_m = 20	Weight	= 0.061